

# Real-time Automatic Modulation Classification using RFSoc

Stephen Tridgell (Waymo\*) - [stridge@waymo.com](mailto:stridge@waymo.com)

David Boland (University of Sydney) – [david.boland@sydney.edu.au](mailto:david.boland@sydney.edu.au)

Philip H.W. Leong (University of Sydney) - [philip.leong@sydney.edu.au](mailto:philip.leong@sydney.edu.au)

Ryan Kastner (UCSD) - [kastner@ucsd.edu](mailto:kastner@ucsd.edu)

Alireza Khodamoradi (UCSD) - [alirezak@eng.ucsd.edu](mailto:alirezak@eng.ucsd.edu)

Siddhartha (University of Sydney) - [siddhartha.siddhartha@sydney.edu.au](mailto:siddhartha.siddhartha@sydney.edu.au)

\*work done while at University of Sydney



THE UNIVERSITY OF  
SYDNEY

- > Automatic Modulation classifier: 488K class/s, 8us latency for CNN

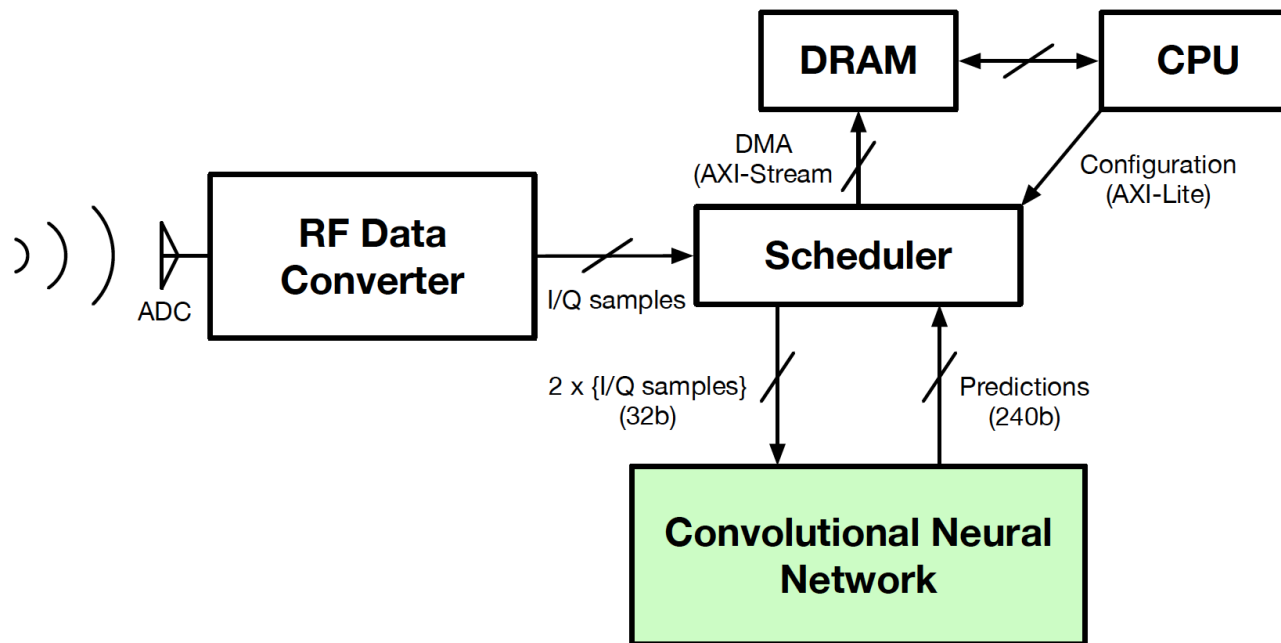

- › Hard to make fully parallel implementations of a NN on contemporary FPGA due to size
- › Fit entire DNN on FPGA by exploiting unstructured sparsity and the following techniques:
  1. Buffering of streaming inputs in a pipelined manner
  2. Ternary weights implemented as pruned adder trees
  3. Common subexpression merging
  4. 16-bit bit serial arithmetic to minimize accuracy loss with low area
  5. Sparsity control
- › Apply this to AMC

## > Weights are ternary

- Reduces convolution to constructing adder tree
- Subexpression merged to reduce implementation

$$\begin{array}{ccc}
 a \times (-1) & b \times 0 & c \times 1 \\
 d \times 0 & e \times 1 & f \times 1 \\
 g \times 0 & h \times (-1) & i \times 0
 \end{array}$$

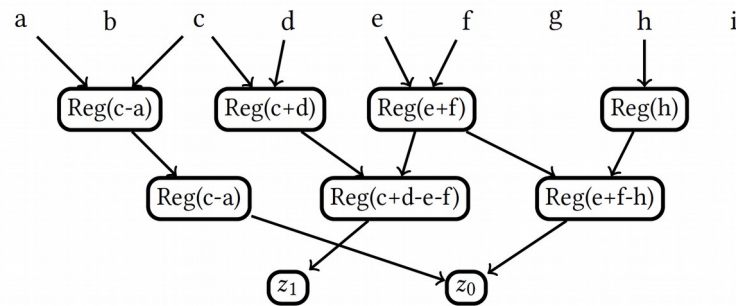

Computing  $z_0 = c + e + f - (a + h)$  and  $z_1 = c + d - e - f$

# Throughput matching with serial adders

- > Activations are 16-bit
  - Not all layers have same throughput
  - Use digit serial to make more compact
  - 4-bit digit serial has 1/4 area
  - 1-bit bit serial has 1/16 area

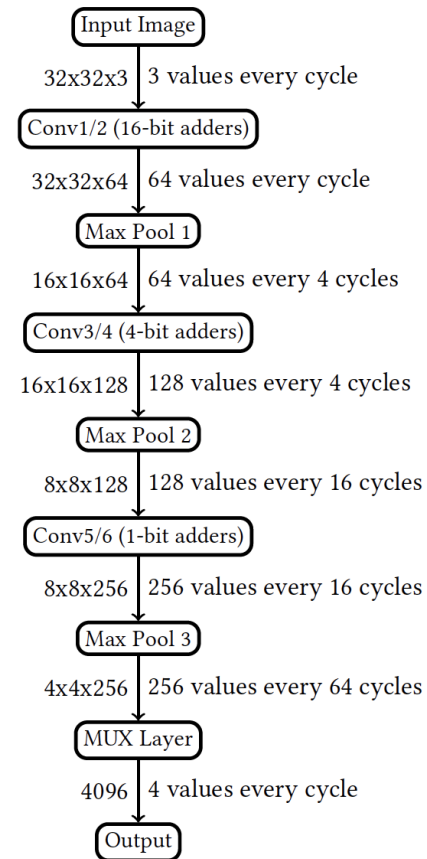
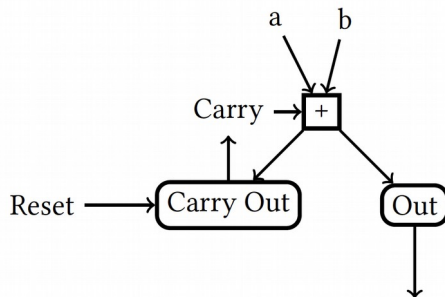

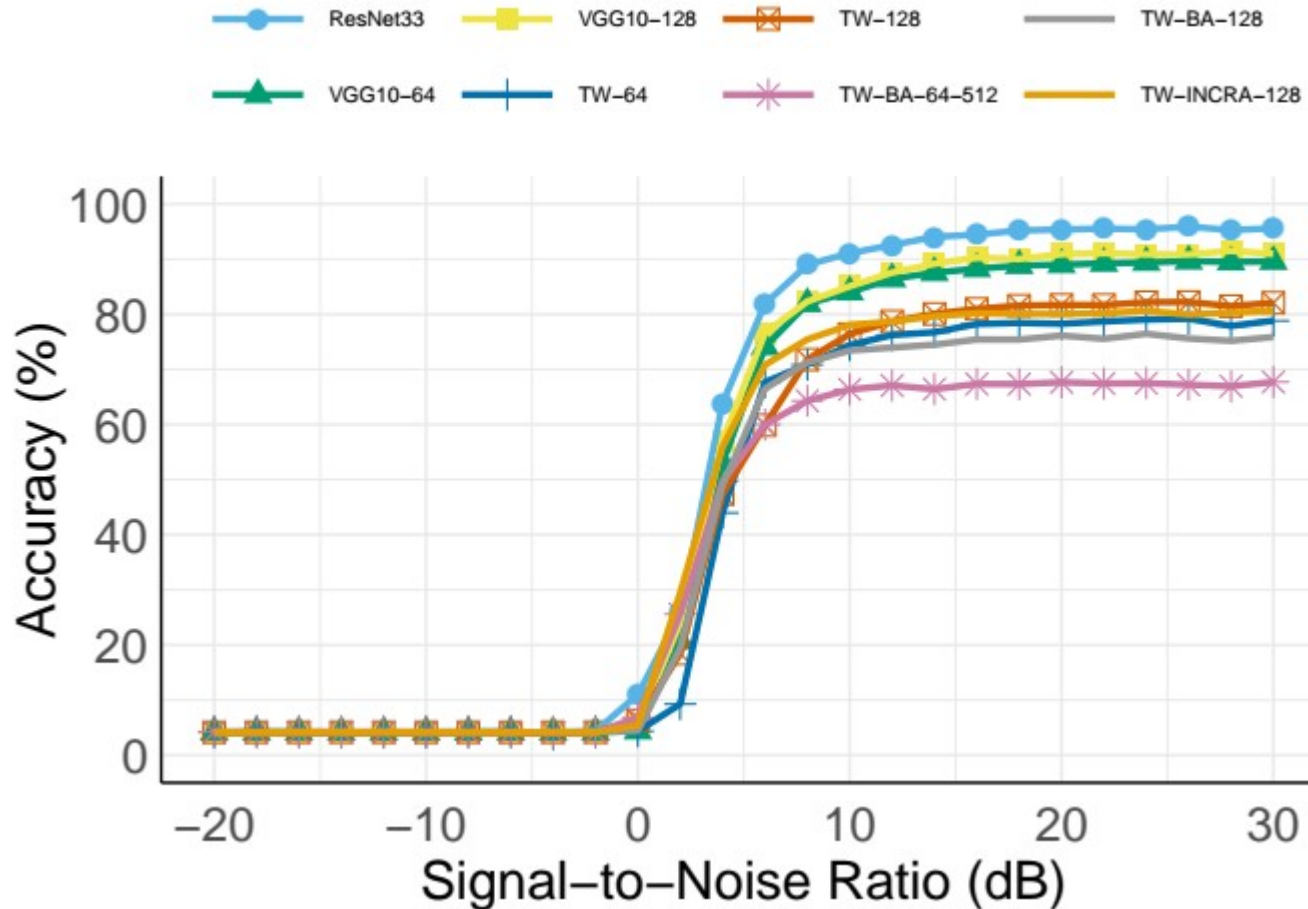

- > Use incremental precision activations instead of 16 bit
  - Use bit serial adders everywhere
  - Adjust precision to match the throughput
  - Same area as binary activations
  - Almost 5% accuracy gain over binary activations

Model	TW-64	TW-96	TW-BA-128	TW-INCRA-128
CLBs	28k (53.5%)	47k (89.3%)	43k (80.7%)	42k (80.2%)
LUTs	124k (29.1%)	232k (54.7%)	234k (55.1%)	211k (49.6%)
FFs	217k (25.5%)	369k (43.4%)	333k (39.2%)	324k (38.1%)
BRAMs	524 (48.5%)	524 (48.5%)	523 (48.4%)	512.2 (48.3%)
DSPs	1496 (35%)	1207 (28.3%)	1408 (33.0%)	1407 (32.9%)
Accr	78.7	81.1	75.9	80.2

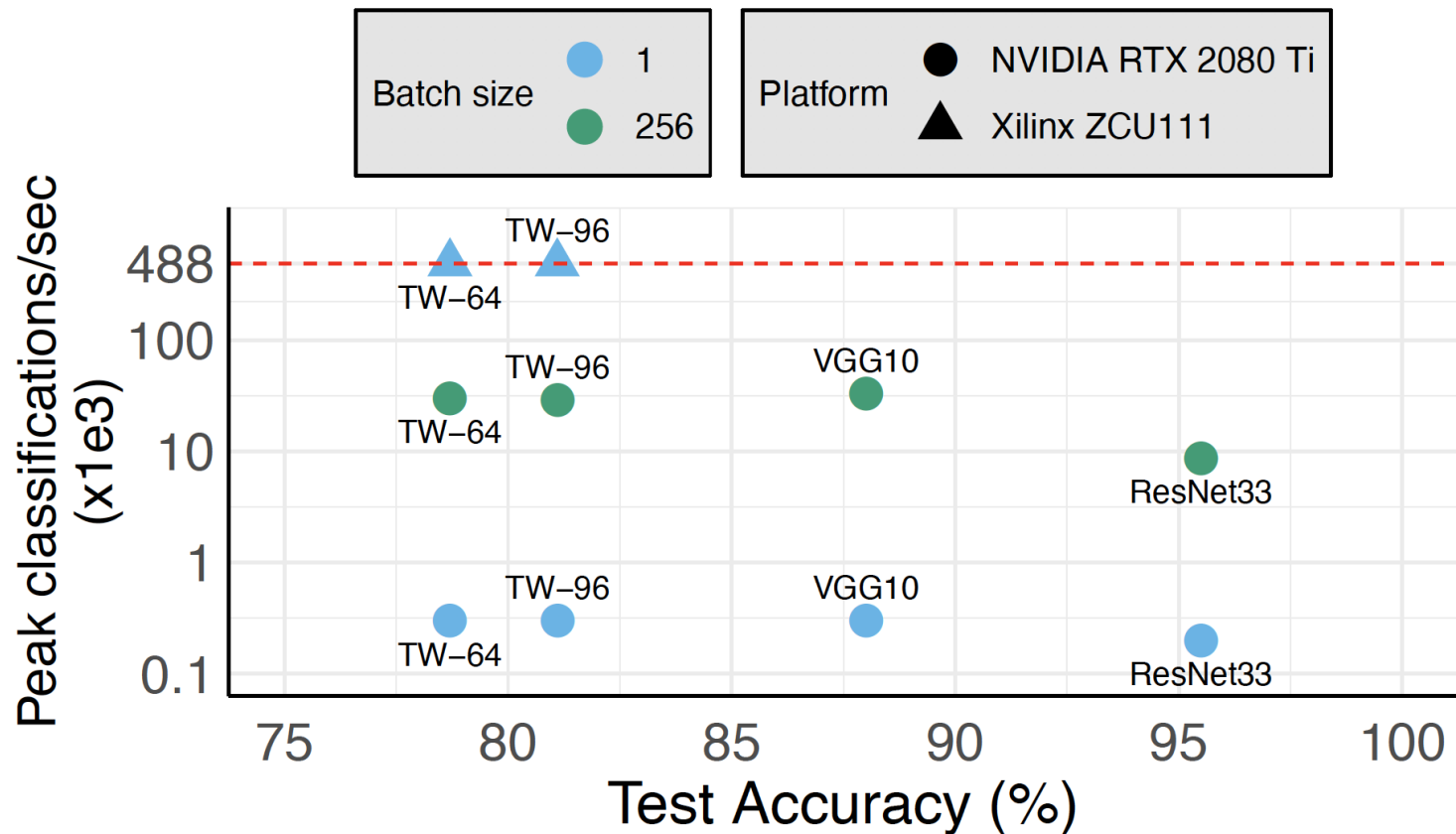



- > System implemented on ZCU111 RFSoc
- > [https://github.com/da-steve101/radio\\_modulation](https://github.com/da-steve101/radio_modulation)
- > Open Source Verilog generator
- > [https://github.com/da-steve101/twn\\_generator](https://github.com/da-steve101/twn_generator)

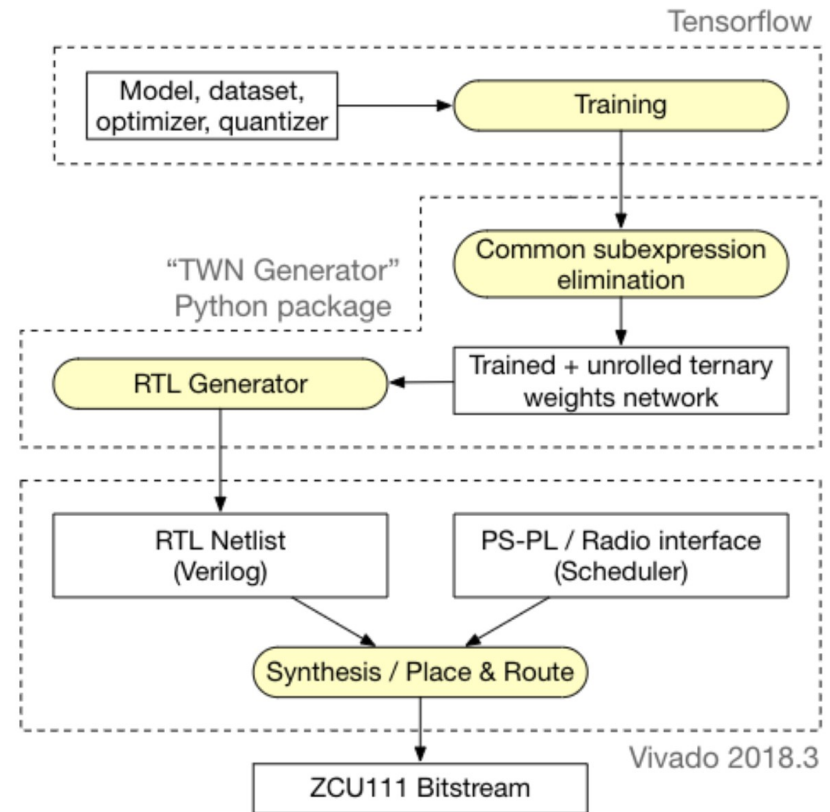

- › Presented an optimized network for AMC which
  - Applies common subexpression elimination and digit serial arithmetic to a fully unrolled ternary network
  - Integrates the entire design on a single chip for a low-latency batch size 1 implementation
- › These serve to achieve a level of performance higher than previously reported
- › Challenge of achieving state of the art accuracy remains